



- COOLE**D Real-time temperature monitoring and control
- BACK2LIF**E Innovative light fixture refurbish and recycle program
- EZ SWAP** Tool-less interchangeable reflector assembly system
- SHIP2FAST** Fast delivery program

MICRO 5" LED TRACK LIGHTING FIXTURE



MICRO	DELIVERED LUMENS	LED COLOR	CRI	BEAM SPREAD	VOLTAGE	HOUSING COLOR	DIMMING OPTION	MOUNTING	TRACK CIRCUIT
MICRO	20 2000 LM (14W) 196LM/W 25 2500 LM (16W) 194LM/W 30 3000 LM (20W) 192LM/W 35 3500 LM (22W) 190LM/W 40 4000 LM (25W) 188LM/W 50 5100 LM (34W) 173LM/W 60 6100 LM (40W) 188LM/W 73 7300 LM (50W) 186LM/W 85 8500 LM (60W) 184LM/W 97 9700 LM (70W) 182LM/W Nominal value at 3500K & 84 CRI.	27 2700 K 30 3000 K 35 3500 K 40 4000 K TW 2700K to 5000K TW1 4000K to 1800K 65W max TW2 6500K to 2700K 65W max B Bread color M Meat color F Fish color	84 nominal CRI at 3500K 90 90 CRI min. value 95 95 CRI (for TW1 & TW2 only) 97 (2700k 3000K 5600K) A A Class*	SP 15° ▲ NFL 24° ▲▲ FL 36° ▲▲▲ WFL 60° ▲▲▲	1 120V 2 277V	WH RAL 9016 white BK RAL 9005 black SL RAL 9006 silver + Custom color	ADIM 0-10V Dim.* ADIM+ 0-10V Dim0.1%* DALI Dalı* TRIAC Triac Dim. ** — None	GLO GLOBAL® STI STUCCHI® LOL LIGHTOLIER® JUN JUNO® HAL HALO® CM Canopy mount	1 1 CCT 2 2 CCT * 3 3 CCT * * ONLY AVAILABLE WITH GLOBALTRAC OR STUCCHI TRACK®

ACCESSORIES : Order as separate part number.

Stucchi ONE TRACK	4',8',12' 3 circuits track with intergrated DALI/0-10V control Recessed/sufrace mount/high track , black, grey, white finish + accessories
Global track	4',8',12' 3 circuits track, surface mount only, white & black finish, no dim.

DELIVERED LUMEN Nominal value at 3500K & 84 CRI

CCT OPTION	2700K	2700K	2700K	3000K	3000K	3000K	3500K	3500K	3500K	4000K	4000K	4000K	Bread	Meat	Fish
CRI OPTION	80	90	97	80/A	90	97	84	90	A/80	84	90	A/80	80	80	80
MULTIPLIER	.93	.77	.67	.96	.80	.71	1	.83	.78	1.0	0.86	.83	.86	.53	1

DIMENSIONS

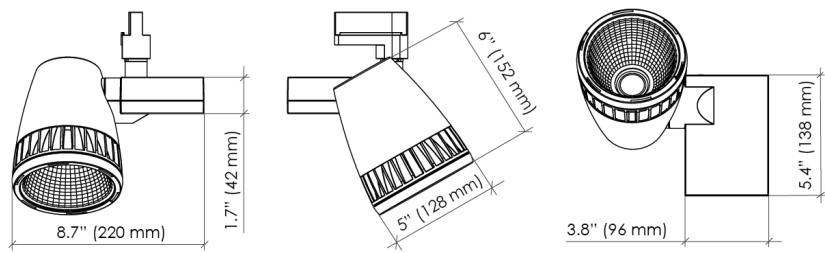

WEIGHT : 3.7 lb (1.7 kg)

ON LIGHT CHEAT SHEET :

- Nominal Efficacy : up to 122.9 lm/W
- Reported Life : 50'000 hrs. in accordance with IESNA TM-21-11.
- 3-Step MacAdam ellipse color consistency for clean and uniform lighting.
- Photometry conducted by independent NVLAP (National Voluntary Laboratory Accreditation Program) accredited testing laboratory in accordance with IESNA LM-79-08.
- Lumen maintenance for luminaire LED's tested by LED chip manufacturer in accordance with IESNA LM80-08.
- 5-year warranty on LED light engine, driver and all lighting fixture components.
- Die-Cast aluminum construction. Track head can be rotated up to 350° and pivoted up to 90°.
- Max settable driver ouput actif cooling : 250W (4100lm-6100lm) / 360W (6100lm-7300lm) / 4100W (5100lm-10900lm).
- Max settable driver ouput static cooling 30W (1000lm-3800lm) /
- Tool-less interchangeable reflector and accessories assembly system



MICRO 5" LED TRACK LIGHTING FIXTURE

CONE OF LIGHT DIAGRAM

(diameter shown is where fc is half the fc at nadir)



Product Family	Beam Spread	CBCP cd	D ft	FC	L ft	W ft	Product Family	Beam Spread	CBCP cd	D ft	FC	L ft	W ft
Power 7300 lumen 3500K 84 CRI	15° (Spot)	26792	10	267.9	4.0	4.0	Power 7300 lumen 3500K 84 CRI	36° (Flood)	17615	10	176.2	5.6	5.6
			12	186.1	4.8	4.8				12	122.3	6.7	6.7
			14	136.7	5.6	5.6				14	89.9	7.9	7.9
			16	104.7	6.4	6.4				16	68.8	9.0	9.0
			18	82.7	7.2	7.2				18	54.4	10.1	10.1
20	67.0	8.0	8.0	20	44.0	11.2	11.2						
Power 7300 lumen 3500K 84 CRI	24° (Narrow Flood)	19334	10	193.3	5.2	5.2	Power 7300 lumen 3500K 84 CRI	60° (Wide Flood)	9008	10	90.1	8.1	8.1
			12	134.3	6.3	6.3				12	62.6	9.8	9.8
			14	98.6	7.3	7.3				14	46.0	11.4	11.4
			16	75.5	8.4	8.4				16	35.2	13.0	13.0
			18	59.7	9.4	9.4				18	27.8	14.6	14.6
20	48.3	10.4	10.4	20	22.5	16.3	16.3						

TECHNICAL PRODUCT SPECIFICATIONS

TRIM HOUSING : Die-cast aluminum housing construction. Track head can be rotated up to 350° and pivoted up to 90°. EZ Swap Tool-less interchangeable reflector assembly system between all track and downlight products.

OPTICAL SYSTEM : Tool-less, user-friendly MIRO ® pure aluminum optical reflector assembly available in four beam spreads: 15°, 24°, 36° & 60°. Faceted/dimpled reflector ensures clean and uniform beam of light.

LED LIGHT ENGINE : BRIDGELUX VERO SERIES 2 or 3 SDCM / 2 or 3 Step MacAdam ellipse multi-chip LED cluster Light Engine yields perfect color consistency with clean and uniform beam of light.

LED DRIVER : Proprietary LED driver with closed-loop LED Light Engine temperature monitoring & control system for long-life (Prevents LED Light Engine damage caused by overheating). Power factor: > 97% at 120 V. Driver output is Class 2 rated.

A CLASS COLOR : Class A is based on human response testing, providing color points with a combined GAI and CRI metric.

FOOD COLOR : Ensures accurate food color rendition of meat, bread or fish in food retailers.

BRIDGELUX CCT : 1750K, 2000K, 2500K, 2700K, 3000K, 3500K, 4000K, 5000K, 5600K, 5700K, 6500K.

R9 VALUE Mini. R9 value for 80 CRI CRI is 0. the min. R9 values for 90 LED is 50. the min. R9 value for 97 CRI LED is 93. For Décor series LED, Typical R9 value is 98 to enhance RED's and an R15 value of 97

TUNABLE WHITE : Tunable white: 6500K to 2700K CCT range or 4000K to 1800K CCT. CRI 95 white both channels powered on. Max 45W per channel. Or Bridgelux VESTA LED 2700K to 5000K CCT range 90CRI.

COOLING SYSTEM : COOLED Temperature sensor/Integrated Circuit controlled brushless MagLev® fan which features zero friction without contact between shaft and bearing. Rated acoustic noise: 17 dBA (nearly inaudible). Rated life: 60'000 hrs

DIMMING Dimming down to 25% or 0.1% (for 0.1% dim. Max. input is 70W).

CERTIFICATION : CSA certified to US and Canadian safety standards. Photometrically tested by NVLAP accredited testing laboratory in accordance with IESNA LM-79-08. LED Light Engine tested by LED chip manufacturer in accordance with IESNA LM-80-08. Lighting Facts qualified.

FINISH : Roughed textured powder-coated paint finish. Available in RAL 9016 white, RAL 9005 black and RAL 9006 silver. Track adapter/ canopy will match luminaire color.

WEIGHT : Trim : 3.7 lb (1.7 kg)

CANOPY MOUNT Round canopy, to be mounted on 4" junction box. Canopy will match luminaire color.

ENVIRONMENT : Rated for dry locations only. Applications in damp or wet locations will void warranty.

REPORTED LIFE : 50'000 hrs at L77 in accordance with IESNA TM-21-11 (Projecting Long Term Lumen Maintenance of LED Light Sources).

WARRANTY : 5-year comprehensive system warranty (LED Light Engine, LED Driver and luminaire parts).

BACK TO LIFE : Luminaire can be refurbished with the newest generation of LED and driver.

























INPUT WATTAGE : Max settable driver output : 50W(3000lm-6100lm) / 60W(6100lm-7300lm) / 100W(5100lm-9700lm).

MADE IN CANADA : Luminaires are assembled in Canada, Beloeil.

GAI GAI value 80 @ CRI93

Due to continuous improvements, the information herein may be changed without notice

ONETRACK 120V 3 CIRCUITS STANDARD TRACK

ITEM	Article n°	Description	ITEM	Article n°	Description	ITEM	Article n°	Description
	9000-UL4/...-ST-120	White, Black, Grey track 120V 3 circuits 4'		9011/...-3C	White, Black, Grey L-feed polarity internal		S-9000/231-...	W, B, G Bracket with automatic gripper
	9000-UL8/...-ST-120	White, Black, Grey track 120V 3 circuits 8'		9012/...-3C	White, Black, Grey L-feed polarity external		S-9000/216	Round head ceiling attachment
	9000-UL12...-ST-120	White, Black, Grey anodized track 120V 3 circuits 12'		9013/...-3C	White, Black, Grey T-feed polarity external left/polarity left		S-9000/211-S-3	3m (10') Steel cable
	9001-CL/...-3C	W, B End-Feed with Circuit Breakers, neutral right side		9014/...-3C	White, Black, Grey T-feed polarity external left/polarity right		S-9000/211-S-5	5m (15') Steel cable
	9002-CL/...-3C	W, B End-Feed with Circuit Breakers, neutral left side		9015/...-3C	White, Black, Grey T-feed polarity internal right/polarity left		XP1-EY90*G-10	10' steel cable with 1/4" anchor 90 Eyelet
	9001/...-3C	W, B, G End-Feed with, neutral right side		9016/...-3C	White, Black, Grey T-feed polarity internal left/polarity right		XP1-EY90*G-15	15' steel cable with 1/4" anchor 90 Eyelet
	9002/...-3C	W, B, G End-Feed with, neutral left side		9017/...-3C	White, Black, Grey adjustable corner		S-9000/T	Cutting tool for track conductors
	9003/...	W, B, G jointing connector		9018/...-3C	White, Black, Grey X-feed			
	9004/...	W, B, G end cap						
	9010/...-3C	W, B, G middle feed						

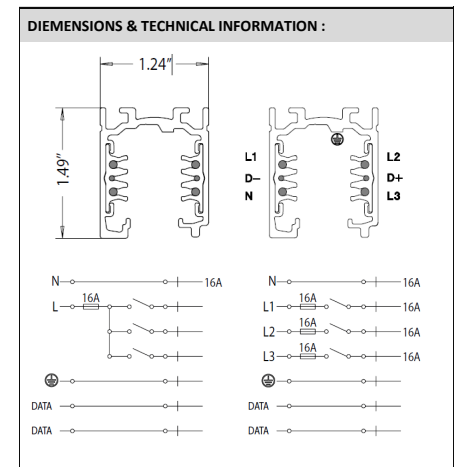
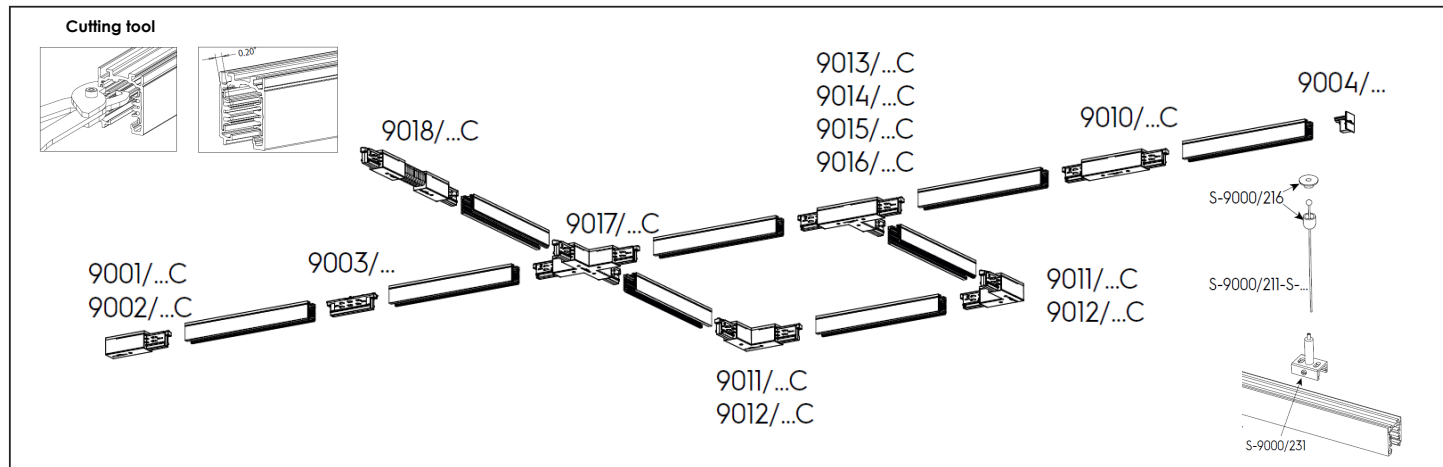

ONETRACK 120V 3 CIRCUITS RECESSED TRACK

ITEM	Article n°	Description	ITEM	Article n°	Description		
	9000-UL4/...-R-120	White, Black, Grey ressed track 120V 3 circuits 4'		9011/...-3C	White, Black, Grey L-feed polarity internal		S-9000/231-... W, B, G Bracket with automatic gripper
	9000-UL8/...-R-120	White, Black, Grey ressed track 120V 3 circuits 8'		9012/...-3C	White, Black, Grey L-feed polarity external		S-9000/216 Round head ceiling attachment
	9001-CL/...-3C	W, B End-Feed with Circuit Breakers, neutral right side		9013/...-3C	White, Black, Grey T-feed polarity external left/polarity left		S-9000/211-S-3 3m (10') Steel cable
	9002-CL/...-3C	W, B End-Feed with Circuit Breakers, neutral left side		9014/...-3C	White, Black, Grey T-feed polarity external left/polarity right		S-9000/211-S-5 5m (15') Steel cable
	9001/...-3C	W, B, G End-Feed with, neutral right side		9015/...-3C	White, Black, Grey T-feed polarity internal right/polarity left		XP1-EY90*G-10 10' steel cable with 1/4" anchor 90 Eyelet
	9002/...-3C	W, B, G End-Feed with, neutral left side		9016/...-3C	White, Black, Grey T-feed polarity internal left/polarity right		XP1-EY90*G-15 15' steel cable with 1/4" anchor 90 Eyelet
	9003/...	W, B, G jointing connector		9017/...-3C	White, Black, Grey adjustable corner		S-9000/T Cutting tool for track conductors
	9004-R/...	W, B, G end cap for recessed track		9018/...-3C	White, Black, Grey X-feed		
	9010/...-3C	W, B, G middle feed		S-9011-R/6-...	White, Black, Grey recessed cover for L-feed		
	S-9001-R/6-...	W, B, G recessed cover for end feed		S-9013-R/6-...	White, Black, Grey recessed cover for T-feed		
	S-9010-R/6-...	W, B, G recessed cover for middle feed		S-9017-R/6-...	White, Black, Grey recessed cover for X-feed		

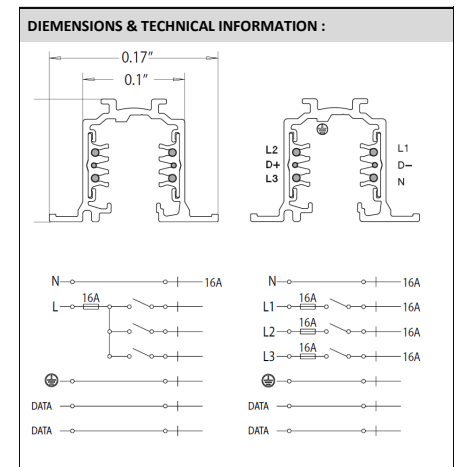
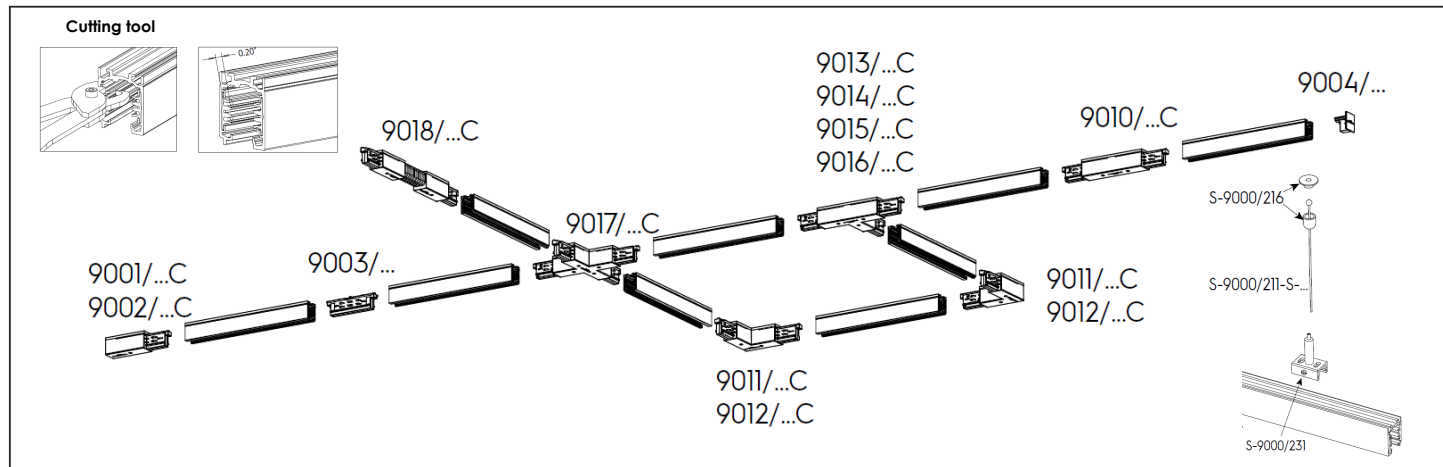





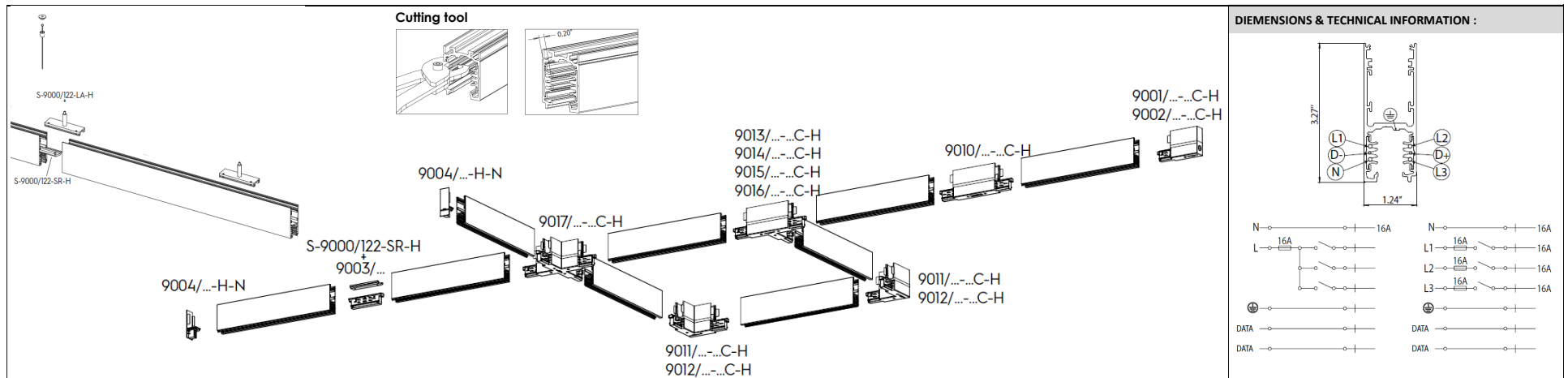















ONETRACK 120V 3 CIRCUITS H TRACK

Article n°	Description	Article n°	Description	Article n°	Description
9000-UL4/...-H-120	White, Black, Grey track 120V 3 circuits 4'	9011/...-3C-H	White, Black, Grey L-feed polarity internal	S-9000/122-LA-H	Bracket with automatic gripper
9000-UL8/...-H-120	White, Black, Grey track 120V 3 circuits 8'	9012/...-3C-H	White, Black, Grey L-feed polarity external	S-9000/122-SR-H	Joining connector
9001-CL/...-3C	W, B End-Feed with Circuit Breakers, neutral right side	9013/...-3C-H	White, Black, Grey T-feed polarity external left/polarity left	S-9000/216	Round head ceiling attachment
9002-CL/...-3C	W, B End-Feed with Circuit Breakers, neutral left side	9014/...-3C-H	White, Black, Grey T-feed polarity external left/polarity right	S-9000/211-S-3	3m (10') Steel cable
9001/...-3C-H	W, B, G H End-Feed with, neutral right side	9015/...-3C-H	White, Black, Grey T-feed polarity internal right/polarity left	S-9000/211-S-5	5m (15') Steel cable
9002/...-3C-H	W, B, G H End-Feed with, neutral left side	9016/...-3C-H	White, Black, Grey T-feed polarity internal left/polarity right	XP1-EY90*G-10	10' steel cable with 1/4" anchor 90 Eyelet
9003/...	W, B, G jointing connector	9017/...-3C-H	White, Black, Grey adjustable corner	XP1-EY90*G-15	15' steel cable with 1/4" anchor 90 Eyelet
9004/...-H	W, B, G H end cap			S-9000/T	Cutting tool for track conductors
9010/...-3C-H	W, B, G H middle feed				



ONETRACK 120V 3 CIRCUITS ROUND TRACK

ITEM	Article n°	Description	ITEM	Article n°	Description		
	9000-UL4/...-ST-120	White, Black, Grey Round track 120V 3 circuits 4'		9011/...-3C	White, Black, Grey Round L-feed polarity internal		S-9000-P7-...
	9000-UL8/...-ST-120	White, Black, Grey Round track 120V 3 circuits 8'		9012/...-3C	White, Black, Grey Round L-feed polarity external		S-9000/216
	9001-CL/...-3C	W, B End-Feed with Circuit Breakers, neutral right side		9013/...-3C	White, Black, Grey T-feed polarity external left/polarity left		S-9000/211-S-3
	9002-CL/...-3C	W, B End-Feed with Circuit Breakers, neutral left side		9014/...-3C	White, Black, Grey T-feed polarity external left/polarity right		S-9000/211-S-5
	9001/...-3C	W, B, G Round End-Feed with, neutral right side		9015/...-3C	White, Black, Grey T-feed polarity internal right/polarity left		XP1-EY90*G-10
	9002/...-3C	W, B, G Round End-Feed with, neutral left side		9016/...-3C	White, Black, Grey T-feed polarity internal left/polarity right		XP1-EY90*G-15
	9003/...	W, B, G jointing connector		9017/...-3C	White, Black, Grey adjustable corner		S-9000/T
	9004/...	W, B, G round end cap					

Cutting tool

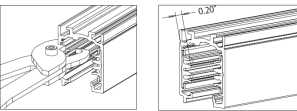
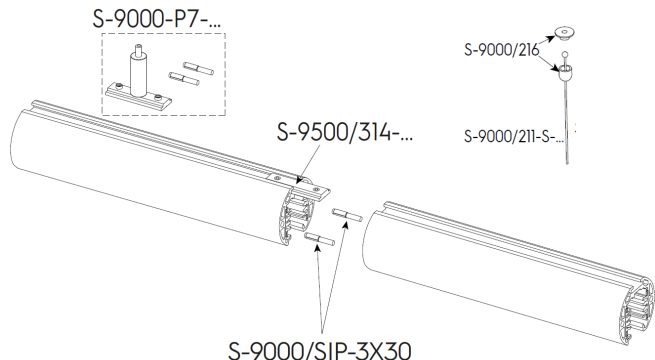
DIEMENSIONS & TECHNICAL INFORMATION :

