



SWAP Tool-less interchangeable reflector assembly system
SHIP2FAST Fast delivery program

ansorg

ON LIGHT

Iqona IMT 3" LED TRACK LIGHT



IMT	DELIVERED LUMENS	LED COLOR	CRI	BEAM SPREAD	HOUSING COLOR	DIMMING OPTION	MOUNTING
Iqona IMT	15 1500 LM (11W) 199LM/W 20 2000 LM (14W) 196LM/W 25 2500 LM (16W) 194LM/W 30 3000 LM (20W) 192LM/W 35 3500 LM (22W) 190LM/W 40 4000 LM (25W) 188LM/W *Custom lumen output on request.	27 2700 K 30 3000 K 35 3500 K 40 4000 K 50 5000 K B Bread color M Meat color F Fish color	80 80 CRI min. value 90 90 CRI min. value 97 (2700k 3000K 5600K) A A Class* (3000K, 3500K, 4000K)	SP 17° (reflector) SSP 20° (reflector) MFL 22° (reflector) FL 37° (reflector) WFL 54° (reflector) VWFL 66° (reflector)	WH RAL 9016 white BK RAL 9005 black SL RAL 9006 silver * Custom color	ADIM 0-10V Dim.* DALI DALI CASAMBI CASAMBI dim. — None (leave blank) * only with stucchi track	3C 3 circuits GLOBAL® or on Stucchi® track system.

ACCESSORIES : Order as separate part number.	
Stucchi ONE TRACK	4',8',12' 3 circuits track with intergrated DALI/0-10V control Recessed/suface mount/high track , black, grey, white finish + accessories
Global track	4',8',12' 3 circuits track, surface mount only, white & black finish

DELIVERED LUMEN Nominal value at 3500K & 84 CRI															
CCT OPTION	2700K	2700K	2700K	3000K	3000K	3000K	3500K	3500K	3500K	4000K	4000K	4000K	Bread	Meat	Fish
CRI OPTION	84	90	97	80/A	90	97	84	90	A/80	84	90	A/80	80	80	80
MULTIPLIER	.93	.77	.67	.96	.80	.71	1	.83	.78	1.0	0.86	.83	.86	.53	1

DIMENSIONS

*dimensions are in mm

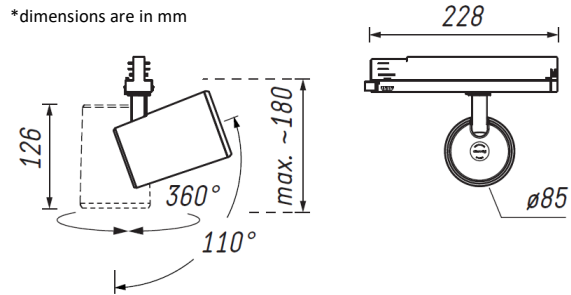

Weight trim: 1.5 lb (0.8 kg) **Diameter:** 3-11/32" (85mm)

Max height: 7" (180mm)

Last update 2/6/2024

ON LIGHT CHEAT SHEET :

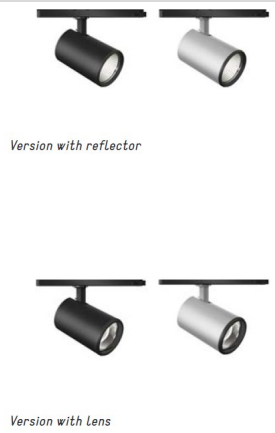

- Nominal Efficacy : up to 199 lm/W
- 3-Step MacAdam ellipse color consistency for clean and uniform lighting.
- Lumen maintenance L80/B10 :50 000h ta 25°C
- 5-year warranty on LED light engine, driver and all lighting fixture components.
- Failure rate C0/B10 : 50 000h ta 25°C
- Input class 2: 120V. Max settable intrack driver output :!25W / 0.22A
- Light fixture number per circuit breaker 20A : 72
- ETL certified to US and Canadian safety standards.
- Tool-less interchangeable reflector and accessories assembly system.
- Mini. R9 value for 80 CRI CRI is 0. the min. R9 values for 90 LED is 50. the min. R9 value for 97 CRI LED is 93. For Décor series LED, Typical R9 value is 98 to enhance RED's and an R15 value of 97
- Luminaires are assembled in Canada, Beloeil.

Due to continuous improvements, the information herein may be changed without notice



EZ SWAP Tool-less interchangeable reflector assembly system
SHIP2FAST Fast delivery program

ansorg







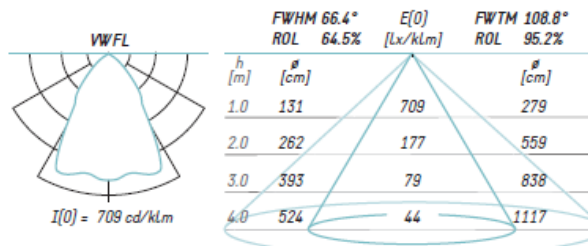
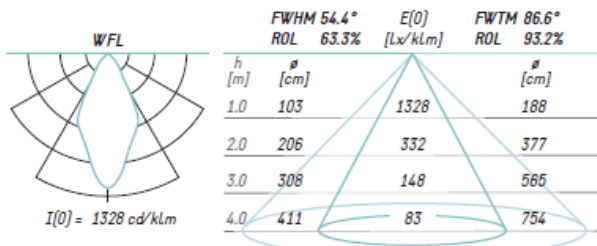
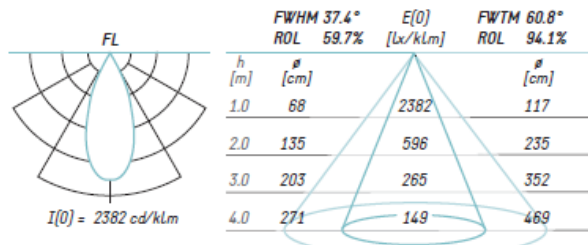
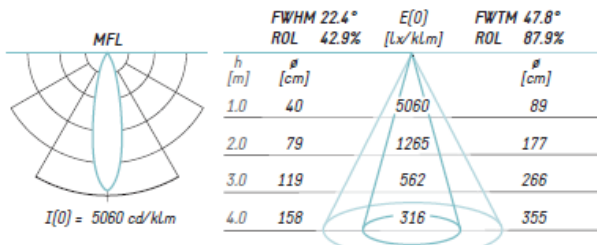
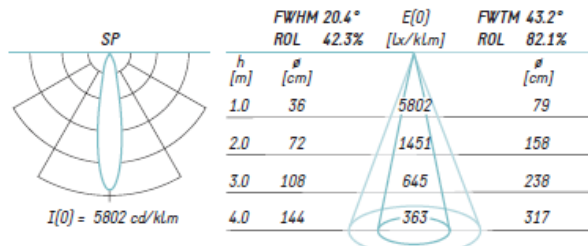
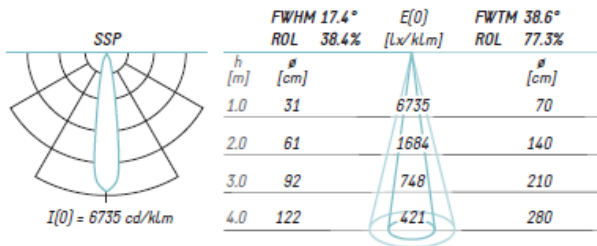

















ON LIGHT

Iqona IMT 3" LED TRACK LIGHT

Light distribution with reflector



ONETRACK 120V 3 CIRCUITS STANDARD TRACK

ITEM	Article n°	Description	ITEM	Article n°	Description	ITEM	Article n°	Description
	9000-UL4/...-ST-120	White, Black, Grey track 120V 3 circuits 4'		9011/...-3C	White, Black, Grey L-feed polarity internal		S-9000/231-...	W, B, G Bracket with automatic gripper
	9000-UL8/...-ST-120	White, Black, Grey track 120V 3 circuits 8'		9012/...-3C	White, Black, Grey L-feed polarity external		S-9000/216	Round head ceiling attachment
	9000-UL12...-ST-120	White, Black, Grey anodized track 120V 3 circuits 12'		9013/...-3C	White, Black, Grey T-feed polarity external left/polarity left		S-9000/211-S-3	3m (10') Steel cable
	9001-CL/...-3C	W, B End-Feed with Circuit Breakers, neutral right side		9014/...-3C	White, Black, Grey T-feed polarity external left/polarity right		S-9000/211-S-5	5m (15') Steel cable
	9002-CL/...-3C	W, B End-Feed with Circuit Breakers, neutral left side		9015/...-3C	White, Black, Grey T-feed polarity internal right/polarity left		XP1-EY90*G-10	10' steel cable with 1/4" anchor 90 Eyelet
	9001/...-3C	W, B, G End-Feed with, neutral right side		9016/...-3C	White, Black, Grey T-feed polarity internal left/polarity right		XP1-EY90*G-15	15' steel cable with 1/4" anchor 90 Eyelet
	9002/...-3C	W, B, G End-Feed with, neutral left side		9017/...-3C	White, Black, Grey adjustable corner		S-9000/T	Cutting tool for track conductors
	9003/...	W, B, G jointing connector		9018/...-3C	White, Black, Grey X-feed			
	9004/...	W, B, G end cap						
	9010/...-3C	W, B, G middle feed						

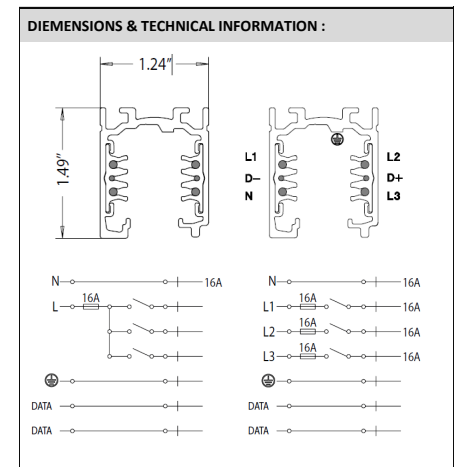
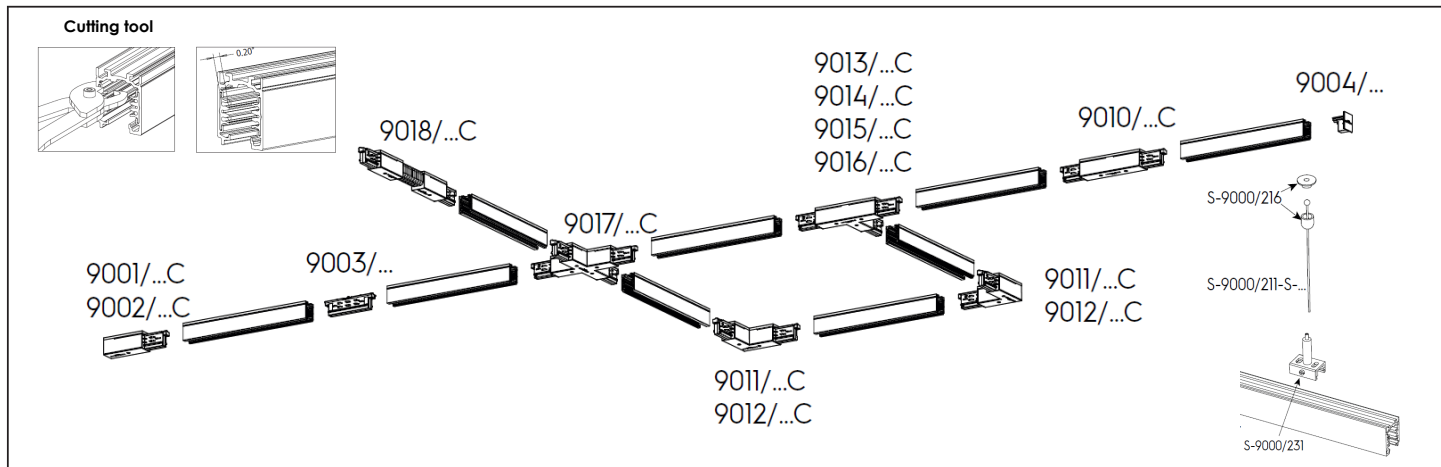

ONETRACK 120V 3 CIRCUITS RECESSED TRACK

ITEM	Article n°	Description	ITEM	Article n°	Description			
	9000-UL4/...-R-120	White, Black, Grey ressed track 120V 3 circuits 4'		9011/...-3C	White, Black, Grey L-feed polarity internal		S-9000/231-...	W, B, G Bracket with automatic gripper
	9000-UL8/...-R-120	White, Black, Grey ressed track 120V 3 circuits 8'		9012/...-3C	White, Black, Grey L-feed polarity external		S-9000/216	Round head ceiling attachment
	9001-CL/...-3C	W, B End-Feed with Circuit Breakers, neutral right side		9013/...-3C	White, Black, Grey T-feed polarity external left/polarity left		S-9000/211-S-3	3m (10') Steel cable
	9002-CL/...-3C	W, B End-Feed with Circuit Breakers, neutral left side		9014/...-3C	White, Black, Grey T-feed polarity external left/polarity right		S-9000/211-S-5	5m (15') Steel cable
	9001/...-3C	W, B, G End-Feed with, neutral right side		9015/...-3C	White, Black, Grey T-feed polarity internal right/polarity left		XP1-EY90*G-10	10' steel cable with 1/4" anchor 90 Eyelet
	9002/...-3C	W, B, G End-Feed with, neutral left side		9016/...-3C	White, Black, Grey T-feed polarity internal left/polarity right		XP1-EY90*G-15	15' steel cable with 1/4" anchor 90 Eyelet
	9003/...	W, B, G jointing connector		9017/...-3C	White, Black, Grey adjustable corner		S-9000/T	Cutting tool for track conductors
	9004-R/...	W, B, G end cap for recessed track		9018/...-3C	White, Black, Grey X-feed			
	9010/...-3C	W, B, G middle feed		S-9011-R/6-...	White, Black, Grey recessed cover for L-feed			
	S-9001-R/6-...	W, B, G recessed cover for end feed		S-9013-R/6-...	White, Black, Grey recessed cover for T-feed			
	S-9010-R/6-...	W, B, G recessed cover for middle feed		S-9017-R/6-...	White, Black, Grey recessed cover for X-feed			

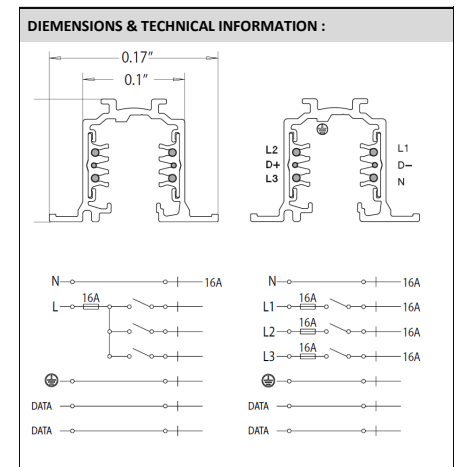
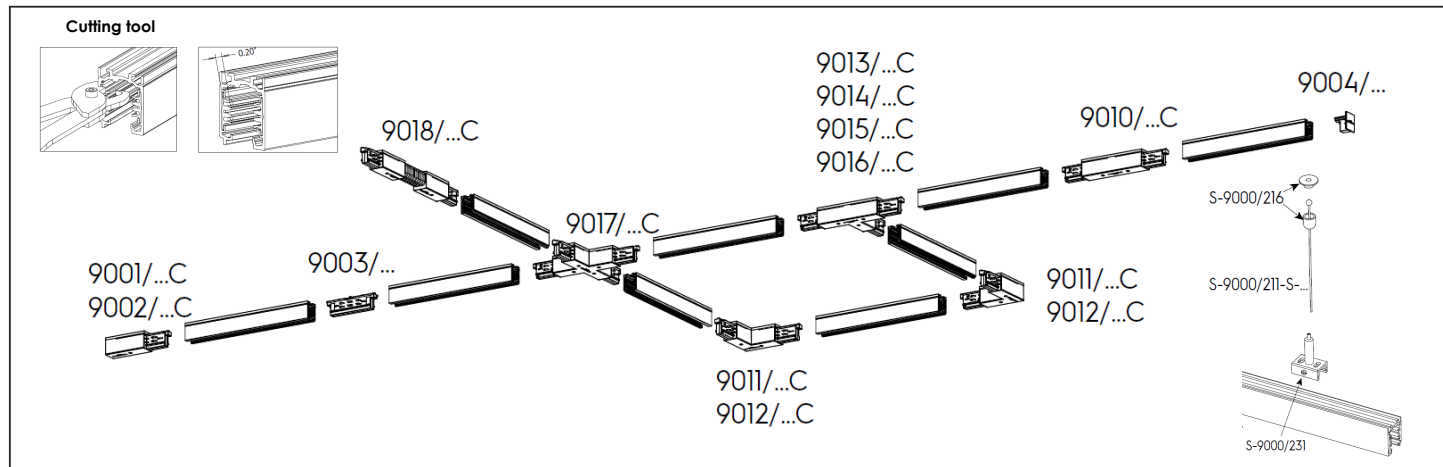





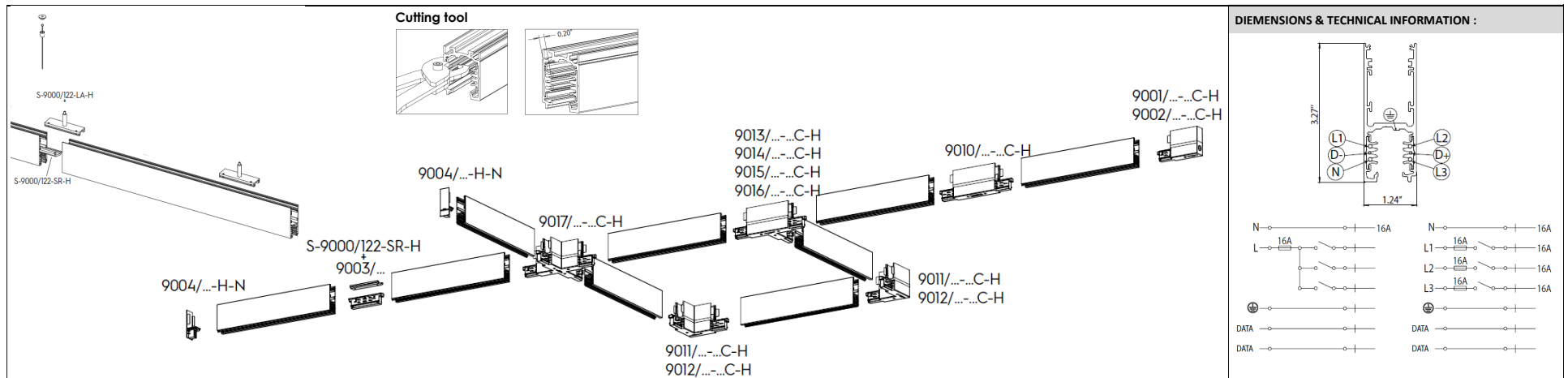















ONETRACK 120V 3 CIRCUITS H TRACK

Article n°	Description	Article n°	Description	Article n°	Description
9000-UL4/...-H-120	White, Black, Grey track 120V 3 circuits 4'	9011/...-3C-H	White, Black, Grey L-feed polarity internal	S-9000/122-LA-H	Bracket with automatic gripper
9000-UL8/...-H-120	White, Black, Grey track 120V 3 circuits 8'	9012/...-3C-H	White, Black, Grey L-feed polarity external	S-9000/122-SR-H	Joining connector
9001-CL/...-3C	W, B End-Feed with Circuit Breakers, neutral right side	9013/...-3C-H	White, Black, Grey T-feed polarity external left/polarity left	S-9000/216	Round head ceiling attachment
9002-CL/...-3C	W, B End-Feed with Circuit Breakers, neutral left side	9014/...-3C-H	White, Black, Grey T-feed polarity external left/polarity right	S-9000/211-S-3	3m (10') Steel cable
9001/...-3C-H	W, B, G H End-Feed with, neutral right side	9015/...-3C-H	White, Black, Grey T-feed polarity internal right/polarity left	S-9000/211-S-5	5m (15') Steel cable
9002/...-3C-H	W, B, G H End-Feed with, neutral left side	9016/...-3C-H	White, Black, Grey T-feed polarity internal left/polarity right	XP1-EY90*G-10	10' steel cable with 1/4" anchor 90 Eyelet
9003/...	W, B, G jointing connector	9017/...-3C-H	White, Black, Grey adjustable corner	XP1-EY90*G-15	15' steel cable with 1/4" anchor 90 Eyelet
9004/...-H	W, B, G H end cap			S-9000/T	Cutting tool for track conductors
9010/...-3C-H	W, B, G H middle feed				



ONETRACK 120V 3 CIRCUITS ROUND TRACK

ITEM	Article n°	Description	ITEM	Article n°	Description		
	9000-UL4/...-ST-120	White, Black, Grey Round track 120V 3 circuits 4'		9011/...-3C	White, Black, Grey Round L-feed polarity internal		S-9000-P7-...
	9000-UL8/...-ST-120	White, Black, Grey Round track 120V 3 circuits 8'		9012/...-3C	White, Black, Grey Round L-feed polarity external		S-9000/216
	9001-CL/...-3C	W, B End-Feed with Circuit Breakers, neutral right side		9013/...-3C	White, Black, Grey T-feed polarity external left/polarity left		S-9000/211-S-3
	9002-CL/...-3C	W, B End-Feed with Circuit Breakers, neutral left side		9014/...-3C	White, Black, Grey T-feed polarity external left/polarity right		S-9000/211-S-5
	9001/...-3C	W, B, G Round End-Feed with, neutral right side		9015/...-3C	White, Black, Grey T-feed polarity internal right/polarity left		XP1-EY90*G-10
	9002/...-3C	W, B, G Round End-Feed with, neutral left side		9016/...-3C	White, Black, Grey T-feed polarity internal left/polarity right		XP1-EY90*G-15
	9003/...	W, B, G jointing connector		9017/...-3C	White, Black, Grey adjustable corner		S-9000/T
	9004/...	W, B, G round end cap					

Cutting tool

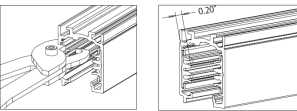
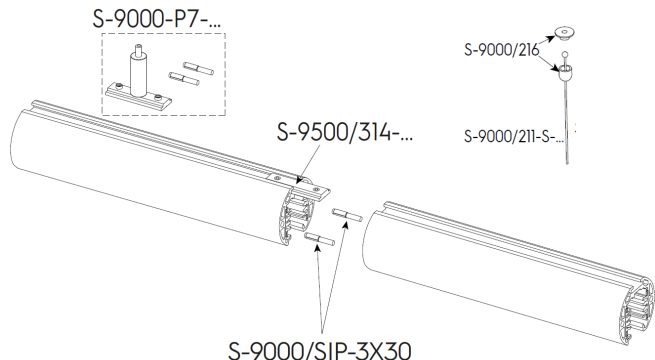
DIEMENSIONS & TECHNICAL INFORMATION :

